



The Safest Connections...

The Lutz Accessory Range
for Electrical & Pneumatic Drum
and Container Pumps



Safety is our Concern

Accessories Lutz Drum and Container Pumps

Accessories for B2 Vario drum and laboratory pump at a glance

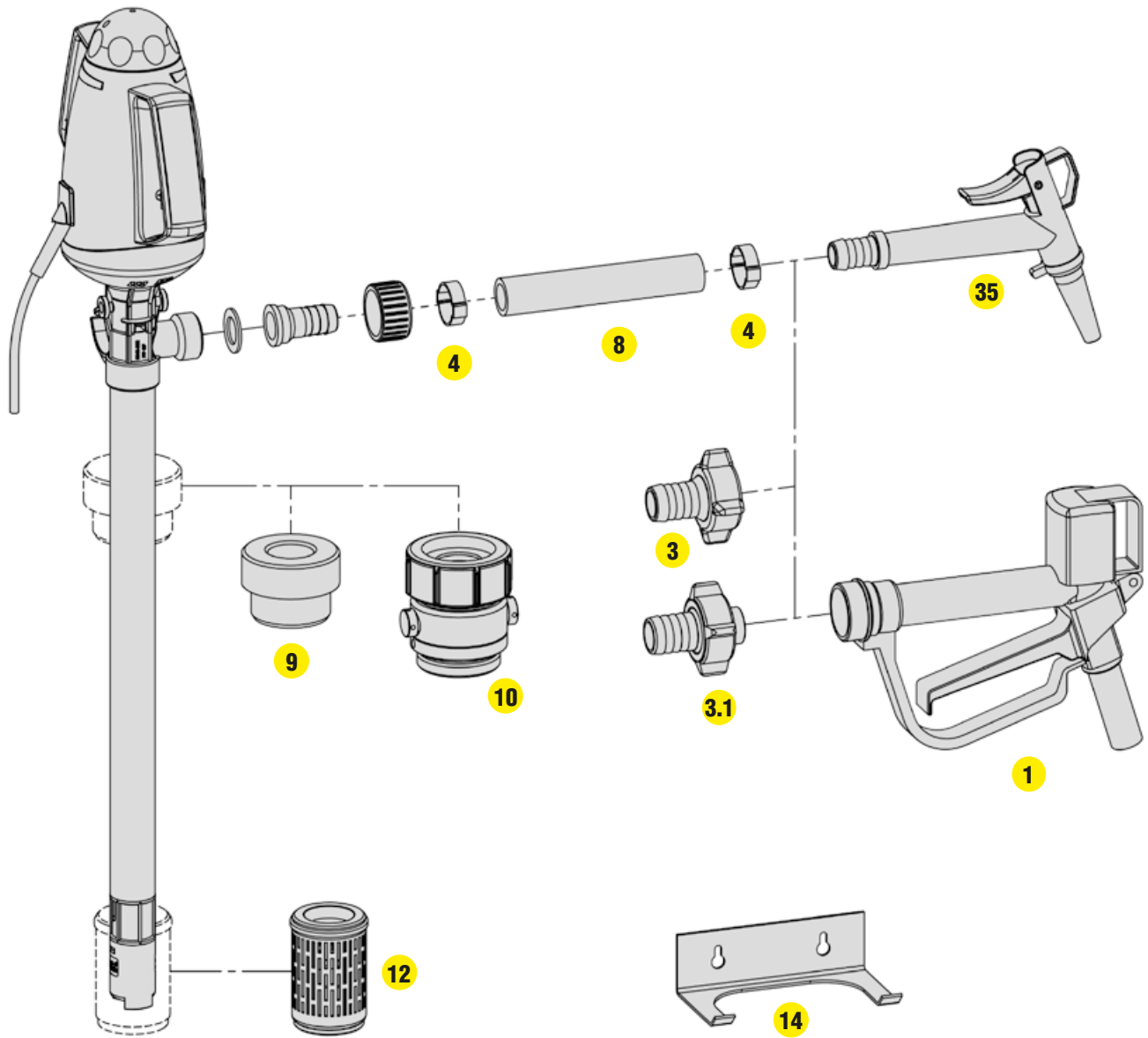

- 1** Nozzle
- 3** Hose connection
- 3.1** Hose connection, rotatable
- 4** Hose clamp
- 8** Hose
- 9** Drum adapter
- 10** Emission proof drum adapter
- 12** Foot strainer
- 14** Wall bracket
- 35** Hand nozzle

Accessories Lutz Drum and Container Pumps

for drum and laboratory pump Lutz B2 Vario

Specification	Order-No.	Product detail
<p>Set-accessories</p> <p>Comprises of: Hand nozzle, 5 feet PVC-hose 3/4", hose connection, hose clamps, wall bracket</p> <p>For Pumps Lutz B2 Vario PP-SL ø 32</p>	0201-003	
<p>35 Hand nozzle PP for Lutz B2 Vario</p> <p>For filling and transferring neutral and aggressive liquids. The liquid stream can be regulated by a turnlock fastener. Outlet spout ø 0.47 inch (conical). Polypropylene (PP) housing. FPM (FPM) seals.</p> <p>Operating pressure: max. 14.5 psi at 68°F Viscosity: max. 300 cps Flow rate: max. 10.5 GPM (water) Temperature of medium: max. 122 °F Weight: approx. 0.22 lbs Connection: hose liner 3/4"</p>	0201-215	
<p>4 Hose clamp</p> <p>Stainless steel hose clamp to fix hoses at the pump outlet connection and accessories.</p> <p>Ear clamp Nominal diameter: 3/4"</p>	0301-257	
<p>9 Drum adapter PP</p> <p>For securing the B2 pump in the drum or container opening.</p> <p>For pump tube: For pump type: ø 1.26 inch PP-SL 32 ø 2.23 inch 0208-009 ø 1.10 inch SS-SL 28 ø 2.23 inch 0208-010</p>	0208-009 0208-010	
<p>10 Emission proof drum adapter</p> <p>To prevent emission of dangerous gases when using a drum pump, so protecting the operator, the environment and the drive motor from hazardous, aggressive gases and vapors. Two venting valves ensure pressure compensation between inside of the drum and surrounding atmosphere.</p> <p>Connection for gas displacement pipe: 3/8", Screw-in thread: 2" outer thread, Seals: FPM</p> <p>Material: For pump type: PP PP-SL 32</p>	0204-251	
<p>12 Foot strainer</p> <p>Made of PP for mounting onto the pump foot. Keeps impurities away from the rotating parts.</p> <p>Material: For pump tube: PP ø 1.26 inch</p>	0204-539	
<p>14 Wall bracket</p> <p>For storage of Lutz B2 Vario drum and laboratory pump. The wall bracket helps to protect pumps from damage and maintain their value.</p> <p>For pump Lutz B2 Vario for Lutz MD-200</p>	0102-079 0102-088	

Accessories Lutz Drum and Container Pumps

At a glance

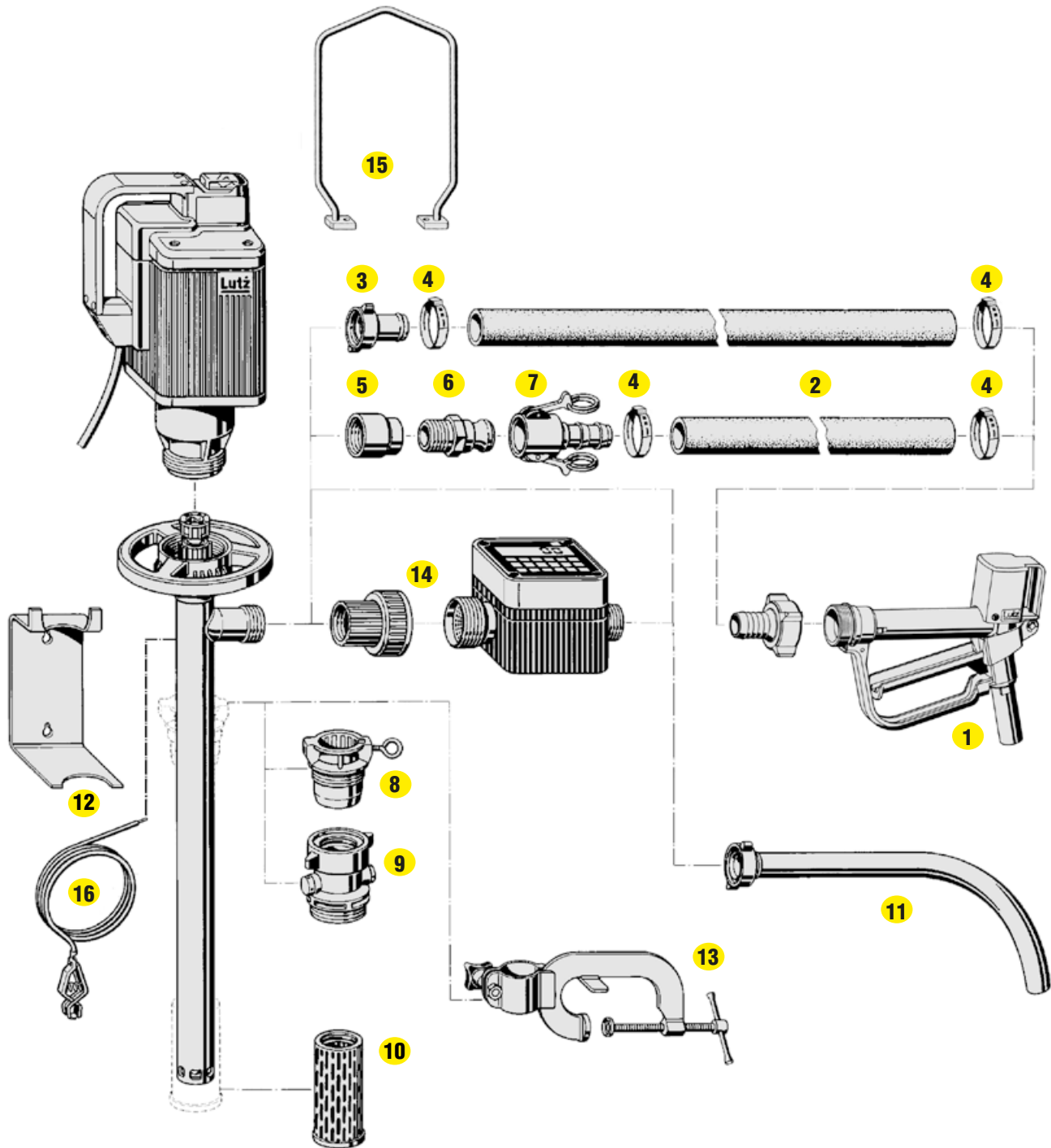



- | | | |
|-------------------------------------|--------------------------------------|-----------------------------------|
| 1 ● Nozzle | 7 Female hose couplings | 13 Side mount clamp |
| 2 Hose | 8 Barrel adaptor | 14 Flow meter |
| 3 Hose connection | 9 Emission proof fume barrier | 15 Lifting bail |
| 4 Hose clamps | 10 Foot strainer | 16 Ground and Bonding wire |
| 5 Reducer | 11 ● Discharge spout | |
| 6 Quick action hose coupling | 12 Wall hanger | |

● Available for use in Hazardous Location and around flammables (Ex), e.g. ethanol, petrol, Items 1,2,5,6,7,8,9,10,11,13,14,15,16

Accessories Lutz Drum and Container Pumps





Dispensing Nozzles

Specification	Order-No.	Product detail
<p>1 PP nozzle</p> <p>For filling and transferring neutral and aggressive liquids. With guard and two outlet spouts \varnothing 0.9" (cylindrical) and \varnothing 1/2" (tapered). Polypropylene (PP) housing and valve tappet. FFPM seals on request.</p>		
<p>Seals:</p> <p>Operating pressure: Viscosity: Flow rate: Temperature of medium: Weight: Connection:</p>	<p>FPM (FPM)</p> <p>max. 43.5 psi at 68°F max. 760 cps max. 13.2 GPM (water) max. 122 °F approx. 0.55 lbs male thread 1 1/4" BSP hose barb 3/4" hose barb 1" hose barb 3/4" with swivel hose barb 1" with swivel</p>	 <p>0204-380 0204-380-1 0204-380-2 0204-380-3 0204-380-4</p>
<p>Seals:</p> <p>Connection:</p>	<p>EPDM</p> <p>male thread 1 1/4" BSP hose barb 3/4" hose barb 1" hose barb 3/4" with swivel hose barb 1" with swivel</p>	<p>0204-385 0204-385-1 0204-385-2 0204-385-3 0204-385-4</p>
<p>Seals:</p> <p>Connection:</p>	<p>PTFE / Encapsulated Models</p> <p>male thread 1 1/4" BSP hose barb 3/4" hose barb 1" hose barb 3/4" with swivel hose barb 1" with swivel</p>	<p>0204-387 0204-387-1 0204-387-2 0204-387-4 0204-387-5</p>
<p>1 PVDF nozzle</p> <p>For filling and transferring neutral and aggressive liquids. With guard and two outlet spouts \varnothing 0.9" (cylindrical) and \varnothing 1/2" (tapered). Polyvinylidenfluoride (PVDF) housing and valve tappet. PTFE encapsulated FPM. FFPM seals upon request.</p>		
<p>Seals:</p> <p>Operating pressure: Viscosity: Flow rate: Temperature of medium: Weight: Connection:</p>	<p>FPM (FPM)</p> <p>max. 43.5 psi max. 760 cps max. 13.2 GPM (water) max. 176 °F approx. 0.7 lbs male thread 1 1/4" BSP hose barb 3/4" hose barb 1" hose barb 3/4" with swivel hose barb 1" with swivel</p>	 <p>0204-390 0204-390-1 0204-390-2 0204-390-4 0204-390-5</p>

● Suitable for transferring combustible and flammable liquids (e.g. ethanol, petrol) or in explosive hazard area.

Accessories Lutz Drum and Container Pumps







Dispensing Nozzles, Hoses

Product detail	Specification	Order-No.
	<p>1 Stainless steel nozzle Ideally suitable for filling and transferring liquids - also for combustible and flammable liquids - in food and pharmaceutical industry. Stainless steel (316) housing and valve tappet. With guard and swivel. FPM seals on request.</p> <p>Seals: FPM (FPM) Operating pressure: max. 43.5 psi Viscosity: max. 760 cps Flow rate: max. 13.2 GPM (water) Temperature of medium: max. 176 °F Weight: approx. 2.2 lbs Connection: male thread 1 1/4" BSP with swivel hose barb 3/4" with swivel hose barb 1" with swivel hose barb 1 1/4" with swivel</p> <p>Seals: PTFE / Encapsulated Models Connection: male thread 1 1/4" BSP with swivel hose barb 3/4" with swivel hose barb 1" with swivel hose barb 1 1/4" with swivel</p>	<p>0204-370 ● 0204-370-1 ● 0204-370-2 ● 0204-370-3 ●</p> <p>0204-377 ● 0204-377-1 ● 0204-377-2 ● 0204-377-3 ●</p>
	<p>1 Brass nozzle Brass housing and valve tappet, nickel-plated. PTFE seals. With guard and swivel. For filling and transferring solvents and neutral liquids.</p> <p>Operating pressure: max. 58 psi Viscosity: max. 760 cps Flow rate: max. 21.1 GPM (water) Temperature of medium: max. 176 °F Weight: approx. 1.32 lbs Connection: hose barb 1"</p>	<p>0372-502-1 ●</p>
	<p>1 Aluminium nozzle with swivel For filling and transferring fuel and diesel oil. Aluminium housing and valve tappet. NBR seals. With guard and swivel.</p> <p>Operating pressure: max. 58 psi Viscosity: max. 760 cps Flow rate: max. 15.9 GPM (water) Temperature of medium: max. 140 °F Weight: approx. 0.88 lbs Connection: hose barb 1"</p>	<p>0372-250-1</p>
	<p>2 PVC hose Transparent PVC hose for non flammable liquids.</p> <p>Operating pressure: max. 87 psi Temperature of medium: 32°F up to 140 °F Nominal diameter: 3/4" 1" 1 1/4"</p>	<p>0374-423 0374-424 0374-425</p>
	<p>2 Electrically conductive hoses with couplings Caution: Electrical conductivity is assured through the use of break-resistant textile copper threads in the rubber coating. If correctly installed, resistance during the entire life of these will remain below 10⁶ ohms.</p>	<p>Contact factory for details</p>

● Suitable for transferring combustible and flammable liquids (e.g. ethanol, petrol) or in explosive hazard area.

Accessories Lutz Drum and Container Pumps

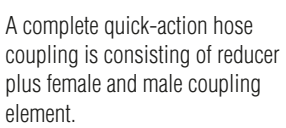
Hose connections

Specification	Order-No.	Product detail
<p>2 Universal chemical hose Color coding: "blue/white/blue". Suitable for 95% of all customary industrial chemicals such as almost all acids and alkalis, mineral oil products and solvents of all kinds. Foodstuff conformity of inner layer. Internal finish: Smooth special lining of ultra high molecular polyethylene (U-PE) with spiralled OHM conductive stripes, electrically conductive. External finish: Electrically conductive EPDM. Light grey with OHM conductive stripes, tin-plated steel wire filament (from DN 25). Type Ω/T smaller than 10⁶ Ohm (acc. to DIN EN 12115:2011).</p> <p>Operating pressure: max. 232 psi Temperature of medium: -22 °F up to 212 °F Nominal diameter: 1"</p>	Contact factory for details	
<p>3 Hose connection included with pumps Material: PP 3/4" all other models 1"</p>		
<p>4 Hose clamps Stainless steel hose clamp to attach hoses/accessories to the pump outlet.</p> <p>Nominal diameter: 11/16" to 1 1/4" 3/4" 1" 1 1/2"</p>	<p>0000-002 0000-001 0000-003</p>	
<p>5 Reducer To connect quick action hose coupling with pump tube. Female thread 1 1/4" BSP female x 1" NPT female</p> <p>Material: Stainless steel 0372-019 ● PP 0204-072</p>		
<p>6 Quick action hose coupling Male adapter</p> <p>Material: Stainless steel 1" male 0372-024 ● PP 1" male 0372-026</p>		
<p>7 Female hose coupling Ensure rapid, water-tight and leakproof connection between pump and hose. Available in stainless steel and polypropylene.</p> <p>Material: Stainless steel 1" Seal FEP/EPDM 0372-025 ● PP 1" Seal FPM 0372-027</p>		 A complete quick-action hose coupling is consisting of reducer plus female and male coupling element.
<p>8 Barrel adaptor Barrel adaptor stabilizes the different model pumptubes in 2" NPT drum and container openings. These are available for all models. For pump tubes: PP, PVDF, MMS/MSL, Alu 0208-007 ● SS, SS, MP SS, RE 88 SS 0204-215 ●</p>		
<p>8 Barrel adaptor in galvanized steel Barrel adaptor stabilizes the different model pumptubes in 2" NPT drum and container openings. These are available for all models. For mixing pump tube PP B70V 0208-013 ● 0204-169 ●</p>		

● Suitable for transferring combustible and flammable liquids (e.g. ethanol, petrol) or in explosive hazard area.

Accessories Lutz Drum and Container Pumps

Emission proof fume barrier



To permit reliable application, emission protection for "on site" pumping operations must be made as convenient as possible under practical conditions. The Lutz fume barrier achieves more for the user with less work:

- ✓ All that is needed is a single drum adapter with two integrated valves.
- ✓ Due to "active seal", emission protection is guaranteed even in the event of wear and tear, damage or pump tube diameter tolerances.
- ✓ The lower part of the adapter can be adapted to varying thread and diameter sizes in container openings.
- ✓ Simple installation using a plug-in-connection for individual adaption.
- ✓ Stability ensured by integrated spring loaded mechanism.
- ✓ Suitable container cup for container emptying available.
- ✓ Larger air valves facilitate pressure equalization by the fast emptying of containers.

Product detail

Specification

Order-No.



9 Emission proof fume barrier

To prevent emission of dangerous gases when using a drum pump, so protecting the operator, the environment and the drive motor from hazardous, aggressive gases and vapors. Two venting valves ensure pressure compensation between the inside of the drum and surrounding atmosphere.

Connection for gas displacement pipe: 3/8" female; 2" male bung thread.

Seals: FPM or EPDM.

Available also with PTFE/Encapsulated FPM.

Material	Pump tube diameter	
PP	1.58 and 1.62 inches	
Brass	1.62 inches	
Stainless steel	1.62 inches	

Hose assembly fume barrier

needed for sealles pump tubes





0204-250
0204-252 ●
0204-253 ●

0204-272

● Suitable for transferring combustible and flammable liquids (e.g. ethanol, petrol) or in explosive hazard area.

Accessories Lutz Drum and Container Pumps

Foot strainers, Discharge spout, Wall hanger, Side mount clamp

Specification	Order-No.	Product detail																				
<p>10 Foot strainer Available in PP, PVDF and stainless steel, for mounting over the pump foot. Keeps impurities away from the rotating parts.</p> <table border="0"> <tr> <td>Material</td> <td>Pump tube</td> <td></td> </tr> <tr> <td>PP</td> <td>PP dia. 1.62"</td> <td>0343-177</td> </tr> <tr> <td>PVDF</td> <td>PVDF and HC dia. 1.62"</td> <td>0343-187</td> </tr> <tr> <td>Stainless steel</td> <td>SS dia. 1.62"</td> <td>0204-617 ●</td> </tr> <tr> <td>Stainless steel</td> <td>B70V</td> <td>0204-802 ●</td> </tr> </table>	Material	Pump tube		PP	PP dia. 1.62"	0343-177	PVDF	PVDF and HC dia. 1.62"	0343-187	Stainless steel	SS dia. 1.62"	0204-617 ●	Stainless steel	B70V	0204-802 ●							
Material	Pump tube																					
PP	PP dia. 1.62"	0343-177																				
PVDF	PVDF and HC dia. 1.62"	0343-187																				
Stainless steel	SS dia. 1.62"	0204-617 ●																				
Stainless steel	B70V	0204-802 ●																				
<p>11 Discharge spout Serving to transfer and fill liquids directly into other vessels. They are available in PP, aluminium and stainless steel and are threaded onto the pump outlet connection.</p> <table border="0"> <tr> <td>Material</td> <td>Nominal diameter</td> <td>Wing nut</td> <td></td> </tr> <tr> <td>PP</td> <td>3/4"</td> <td>1 1/4"</td> <td>0204-200</td> </tr> <tr> <td>Alu</td> <td>1"</td> <td>1 1/4"</td> <td>0204-373</td> </tr> <tr> <td>SS</td> <td>1"</td> <td>1 1/4"</td> <td>0204-225 ●</td> </tr> <tr> <td>SS</td> <td>1 1/2" (for B70V)</td> <td>1 1/2"</td> <td>0204-226 ●</td> </tr> </table>	Material	Nominal diameter	Wing nut		PP	3/4"	1 1/4"	0204-200	Alu	1"	1 1/4"	0204-373	SS	1"	1 1/4"	0204-225 ●	SS	1 1/2" (for B70V)	1 1/2"	0204-226 ●		
Material	Nominal diameter	Wing nut																				
PP	3/4"	1 1/4"	0204-200																			
Alu	1"	1 1/4"	0204-373																			
SS	1"	1 1/4"	0204-225 ●																			
SS	1 1/2" (for B70V)	1 1/2"	0204-226 ●																			
<p>12 Wall hanger For storage of drum pumps. This accessory helps protect pumps from damage, and prolongs the life of the pump tube.</p> <p>This is shipped with all M-series pump tubes.</p>	0204-308																					
<p>12 Wall hanger For storage of drum pumps.</p> <table border="0"> <tr> <td>B70V D/DA</td> <td>0204-309</td> </tr> <tr> <td>B70V-SR</td> <td>0204-307</td> </tr> </table>	B70V D/DA	0204-309	B70V-SR	0204-307																		
B70V D/DA	0204-309																					
B70V-SR	0204-307																					
<p>13 Side mount clamp The side mount clamp secures the drum pumps in open-topped drums and containers. Suitable for various pump tube diameters.</p> <table border="0"> <tr> <td>For pump tubes PP, Alu, SS, PVDF and HC</td> <td>0205-040</td> </tr> <tr> <td>For pump tube B70V dia 52 – 2</td> <td>0205-052</td> </tr> </table>	For pump tubes PP, Alu, SS, PVDF and HC	0205-040	For pump tube B70V dia 52 – 2	0205-052																		
For pump tubes PP, Alu, SS, PVDF and HC	0205-040																					
For pump tube B70V dia 52 – 2	0205-052																					

● Suitable for transferring combustible and flammable liquids (e.g. ethanol, petrol) or in explosive hazard area.

Accessories Lutz Drum and Container Pumps





Flow meter, Lifting bail, Ground and Bonding wire

Product detail	Specification	Order-No.
	<p>14 Electronic flow meter, TR series</p> <p>For easy and precise flow rate measuring of various liquids. Ease of handling, compact design and ideally to combine with all drum and container pumps (connection 1" or 1 1/4"), available in polypropylene (PP) or polyvinylidene fluoride (PVDF).</p> <p>For more details request leaflet 9000-124 rev.</p>	
	<p>14 Modular electronic flow control system, TS series</p> <p>For metering all kinds of liquids. Wide range of applications: Connect directly at the drum pump, remote or in-line operation possible. Convenient pre-setting of required volume using a touch screen display. Multilingual menus and simple plain-text operation. A comprehensive range of system components offers practical problem solutions. Two standard and three explosion-proof meter versions are available.</p> <p>For more details request leaflet 9000-124 rev.</p>	
	<p>15 Lifting bail</p> <p>To simplify the process of lifting the pump in and out of drums and containers. When using an explosion-proof driving motor the Ex-protective plug is mounted onto the lifting device.</p> <p>for B55-T for B4/GT for B70V D/DA with three phase (gear) motor for B70V with pneumatic motor</p>	<p>0211-047 0214-196 0175-621 0172-619</p>
	<p>16 Ground and Bonding wire</p> <p>Serves to create electrically conductive connection between explosion-proof pump and container as earthing and ground and bonding function.</p> <p>Ground wire 6" Bonding wire 10"</p>	<p>0204-994 ● 0204-995 ●</p>

● Suitable for transferring combustible and flammable liquids (e.g. ethanol, petrol) or in explosive hazard area.





Accessories Lutz Drum and Container Pumps

Compressed air hose, Hose clips, Coupling

Product detail	Specification	Order-No.
	<p>22 Compressed air hose hose (rubber material) with intermediate woven layer, 1/2", for air supply to compressed air motors.</p> <p>Operating pressure: 3/8" max. 100 psi</p>	<p>0313-154</p>
	<p>23 Hose clips For compressed air hose 1/2"</p>	<p>0301-256</p>
	<p>24 Coupling (female part) Self-disconnecting in brass, with hose connector 1/2" For compressed air hose 1/2"</p>	<p>0372-167</p>
	<p>M-Tool Special design for repair of Models MMS/MSL-SS, RE88-SS and MPMS-SS</p>	<p>0201-008</p>

Accessories Lutz Drum and Container Pumps

Accessories for eccentric screw pump B70V-H

Specification	Order-No.	Product detail
<p>Hose connection DN 38 to Tri-Clamp DN 50</p>	0172-746	
<p>Adapter fitting Tri-Clamp DN 50 for thread DIN 11851 Rd 78 x 1/6 (DIN 405)</p>	0172-747	
<p>Fastener bracket Tri-Clamp DN 50 (DIN 32676) 1.4401 with seal EPDM</p>	0172-745	
<p>Discharge spout Tri-Clamp DN 50</p>	0172-748	
<p>Pump foot for drum inliner</p>	0172-771	

Required accessories for use in hazardous locations

- 1 Bonding wire
- 2 Ground wire
- 3 Conductive hose, (10⁶ Ohm)
- 4 Conductive fitting of the hose into hose connector
- 5 Metal pump tube for zone „0“ in Stainless steel or Hastelloy „C“
- 6 Explosion-proof motor Lutz Silver Star or MD-1/MD-2/MD-3 (Ex) air motors
- 7 Nozzle in Stainless steel (handregulated)
- 8 Flow control system (Ex)
- 9 Emission proof fume barrier



■ **Bonding** is the electrical interconnection between containers (such as drum and a receiving can). Bonding must be completed before pumping begins. For better conductivity paint and dirt shall be removed from the contact points.

■ **Grounding** is the electrical connection between a container and a "constant ground". A "constant ground" would be a metal pipe (water pipe) or rod in contact with the earth. An underground tank and piping connected to it would be inherently grounded by nature of the installation.

■ Both **Bonding** and **Grounding** of containers of flammable liquids are required under U.S. Government OSHA regulations and National Fire Protection Association Code 77, static electricity.

■ Metal pumps in stainless steel or Hastelloy C and pump motor must be bonded to metal container or grounded, if used with plastic container. Normal safety procedures must be followed at all times when operating any piece of machinery.

Notes

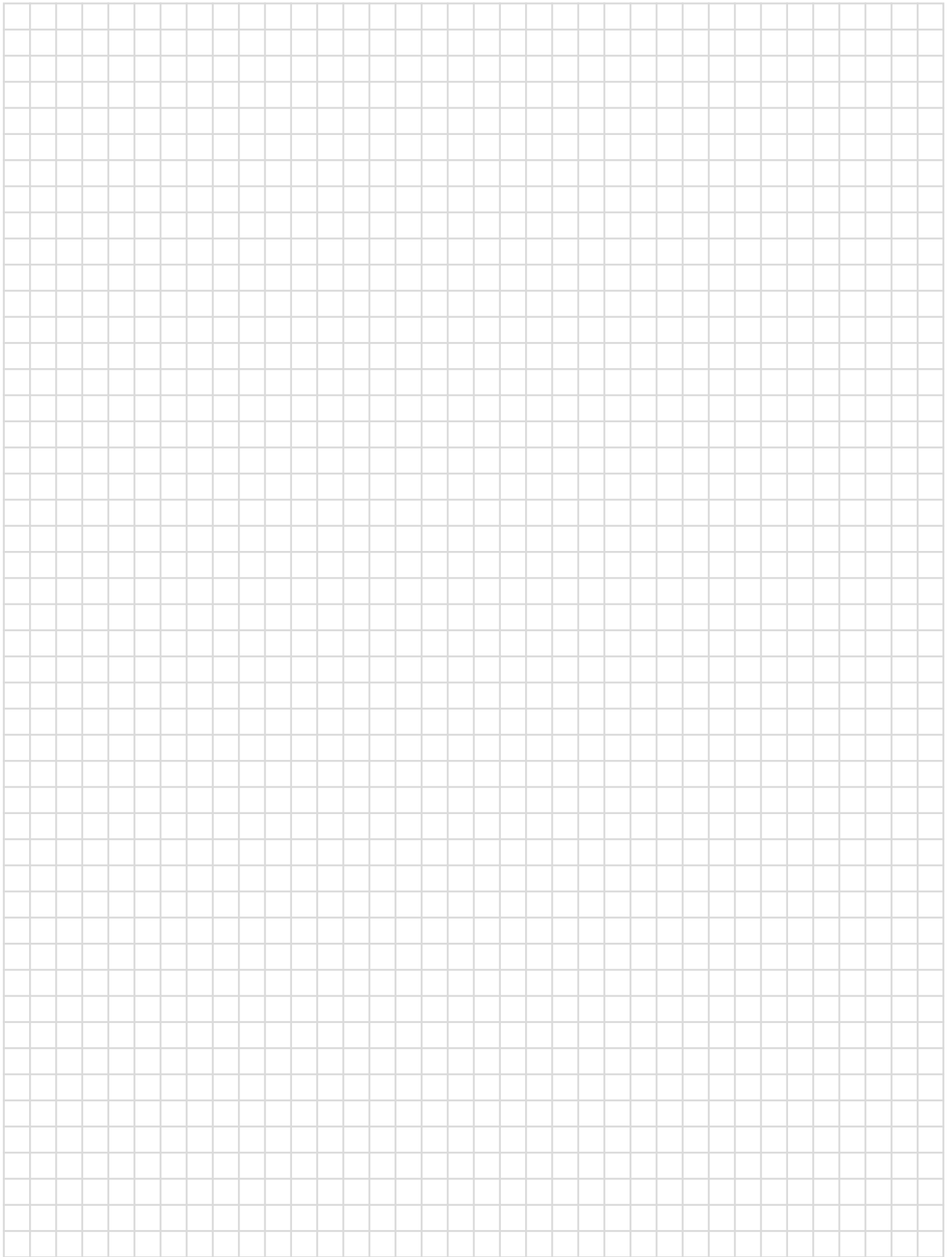



Drum and Container Pumps · Flow Meters · Double Diaphragm Pumps

Lutz offers the optimum solution for professional Fluid Management



Lutz Pumps, Inc.

1160 Beaver Run Road
Norcross, GA 30093-4898
Phone: (770) 925-1222
(800) 843-3901
Fax: (770) 923-0334

www.lutzpumpsamerica.com
e-mail: info@lutzpumpsamerica.com

0699-201